

'S' type core bolted to brackets

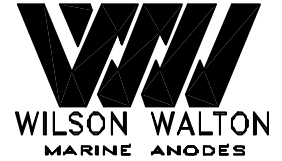
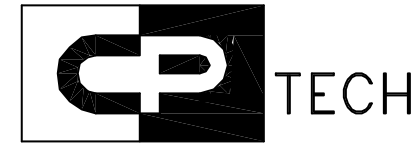

Cathodic Protection Technology Pte Ltd

4 Tuas Drive 1 Singapore 638671

Tel: 6862-3551

Fax: 6861-6436

Email : cptech@singnet.com.sg

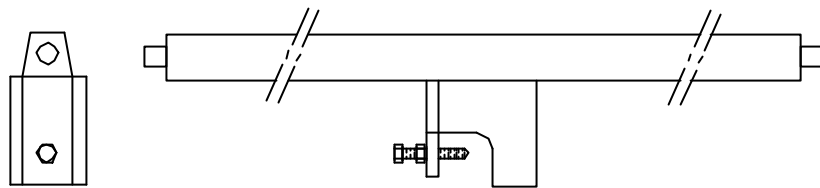

'C' type centre clamps

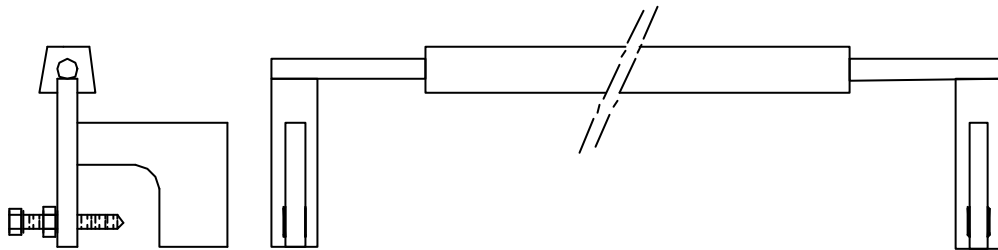
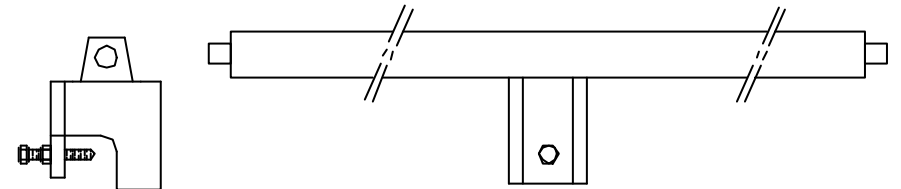

'E' type extended clamp

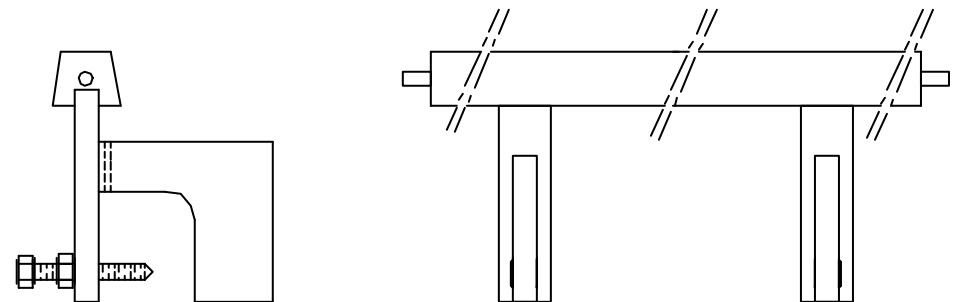

'D' type integral clamp



Cathodic Protection Technology Pte Ltd

4 Tuas Drive 1 Singapore 638671

Tel: 6862-3551

Fax: 6861-6436

Email : cptech@singnet.com.sg

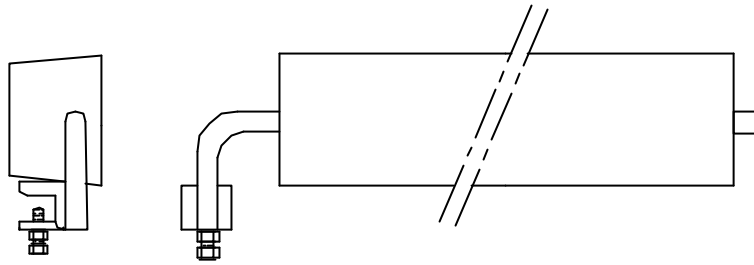

Budget clamp

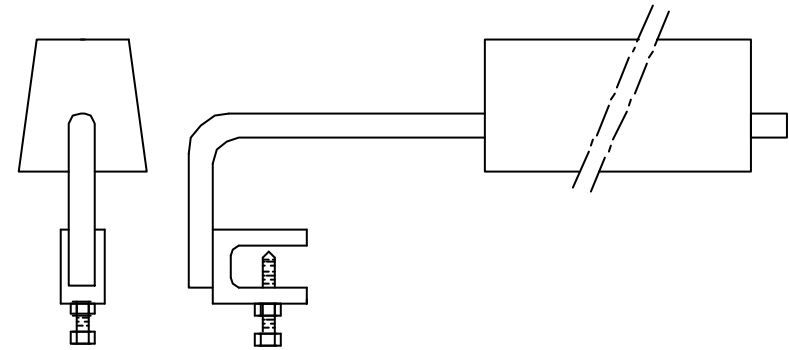

Pitguard clamp

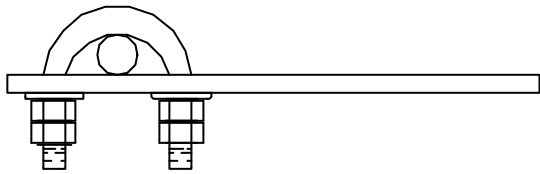

Bolt clamp

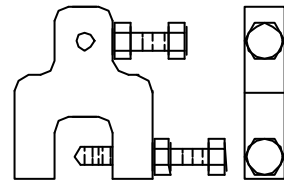

"M" type clamp

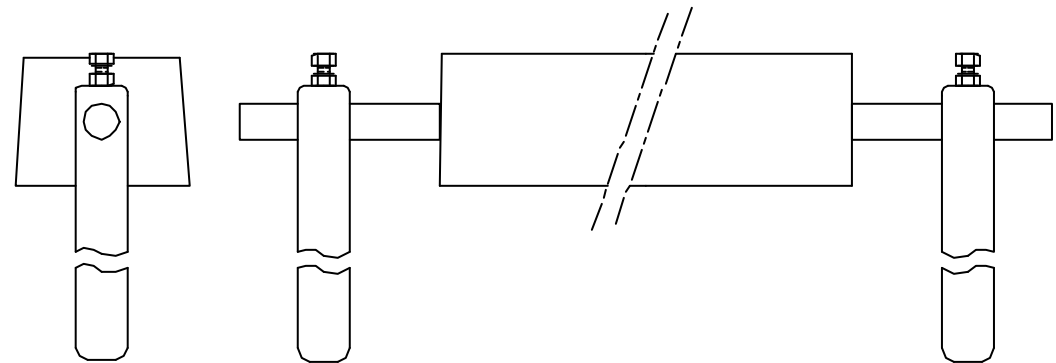

Bar clamp

Alternative Tank Anode Fixing Methods 2



Flat bolt on

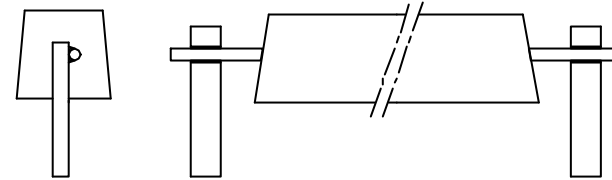

Standard core stand-off bracket, welded fixing

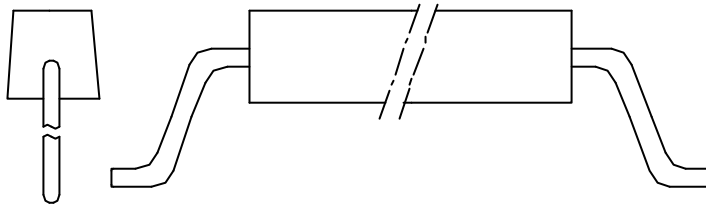

Standard core – double crank

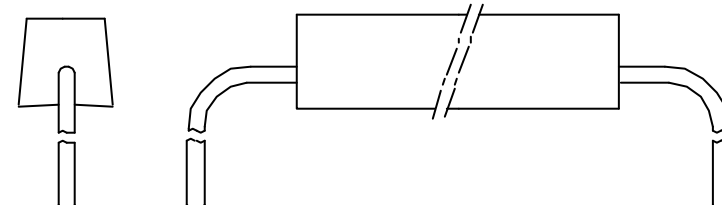

Standard core – single crank

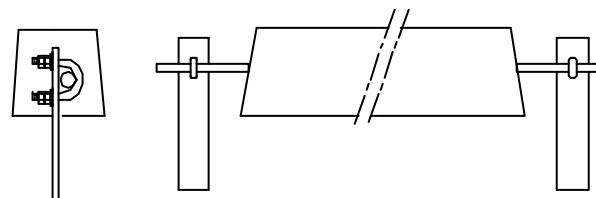

Standard core stand-off bracket, U-bolt fixing